

Quotation Bill of Material

Item	Qty	Product Information
1	1	ACH580-VDR-052A-4 <i>ACH580 6-Pulse drive package rated UL (NEMA) Type 1. Provided with Main Input Disconnect with VFD fuses and E-Clipse Bypass (Vertical). Rated for 52 amps (40 HP) at 480 VAC three phase.</i>

Terms:

- ***FOB ABB Factory***
- ***Proposal valid for 30 days from quotation date***
- ***ABB Inc. Standard Terms and Conditions of Sale apply***
- ***Proposal based upon acceptance of Clarifications and Exceptions to Specifications and Terms provide later in this quotation***

Submittal Schedule

This schedule includes the products supplied as part of this submittal.

Schedule			Motor Data ¹			Drive Data			
Item	Qty	Tag	HP	FLA	Volts	Product ID	HP	Amps	Volts
1	1		40	52	460 VAC	ACH580-VDR-052A-4	40	52	480 VAC
Notes: 1. AC motor data is per National Electrical Code Table 430.250 for typical motors used in most applications. It is provided as typical data only. DC motor data is per typical industry standards. Actual motor data may vary									

Submittal Schedule Details for

Item	Tag / Equipment ID	Product ID
1		ACH580-VDR-052A-4

Item Description
<p>Input Voltage: 480 VAC Three Phase Rated Output Current: 52A Enclosure: UL (NEMA) Type 1 Nominal Horsepower: 40 HP Frame Size: R4 Input Disconnecting Means: Disconnect with VFD fuses Bypass: E-Clipse Bypass (Vertical) Input Impedance: 5% equivalent impedance Short Circuit Current Rating: 100 kA with fusing Communication Protocols: Johnson Controls N2, Modbus RTU, BACnet (MS/TP) Other Options:</p>

Drive Input Fuse Ratings	
Fuse Class	Amps (600 V)
Class T	80

Wire Size Capacities of Power Terminals		
Input Wiring	Output Wiring	Ground Wiring
#14...#4 4.6 lbf-ft	#14...#2 #14...#8: 35 in-lbs; #6...#4: 45 in-lbs; #3...#2: 50 in-lbs	#14...#2 #14...#10: 2.9 lbf-ft; #6...#4: 3.8 lbf-ft; #2: 4.1 lbf-ft

Dimensions and Weights			
Height <i>in</i> (<i>mm</i>)	Width <i>in</i> (<i>mm</i>)	Depth <i>in</i> (<i>mm</i>)	Weight <i>lbs</i> (<i>kg</i>)
56.8 (1443)	8.4 (214)	12.0 (305)	86 (39)

Heat Dissipation & Airflow Requirements			
Power Losses		Airflow	
BTU/Hr	Watts	CFM	CM/Hr
3,130	918	25	42.5

Page Left Blank Intentionally

ACH580-01/-31

The ACH580 drive sets new standards in both simplicity and reliability, and ensures smooth, energy-efficient operation of your HVAC systems in normal and mission-critical situations.

ACH580-01, wall-mounted base drives

The ACH580-01 wall-mounted drives are available from 1 to 100 HP at 208/240 V, 1 to 350 HP at 480 V, and 2 to 250 HP at 575 V. The ACH580-01 drives are available in UL (NEMA) Type 1 and 12 configurations. In standard installations, the drive is mounted directly onto a wall and uses the provided conduit box. Conduit openings are provided for bottom conduit entry & exit. For mounting in a customer-supplied cabinet, the conduit box may be removed. The drive has a 100 kA SCCR rating when paired with appropriately sized upstream fuses.

ACH580-31, ultra low harmonic wall-mounted base drives

The ACH580-31 wall-mounted drives are available from 5 to 400 HP at 480 V. The ACH580-31 are available in UL (NEMA) Type 1 and 12 configurations. In standard installations, the drive is mounted directly onto a wall and uses the provided conduit box. Conduit openings are provided for bottom conduit entry and exit. For mounting in a customer-supplied cabinet, the conduit plate may be removed.

Features for HVAC

The ACH580 comes standard with an intuitive control panel used to configure, control, and monitor the drive. An optional Bluetooth control panel allows the drive to be configured via the control panel or the DriveTune app.

A robust HVAC firmware package provides drive, motor, and application protection features. Examples of drive protection features include undervoltage, overvoltage, overcurrent, and ground fault protection. The ACH580 also has a variety of motor protection features including overload and stall protections.

Application specific features, such as accepting four separate start interlocks (safeties), along with broken belt detection, are also included. The drive includes BACnet MS/TP, Modbus RTU, and Johnson N2 as standard. Additional protocols, such as BACnet/IP and LonWorks, are available with optional fieldbus adapters.

Technical specifications

Product compliance (complete list on following page)

ACH580-01/-31 CE, UL, cUL, and EAC

Supply connection

Input voltage (U_1)	
ACH580-xx-xxxA-2	208/240V
ACH580-xx-xxxA-4	480V
ACH580-xx-xxxA-6	600V
Input voltage tolerance	+10% / -15%
Phase	3-phase (1-phase, 240 V)
Frequency	48 to 63 Hz
Line Limitations	Max $\pm 3\%$ of nominal phase to phase input voltage
Power Factor ($\cos \varphi$) at nominal load	
ACH580-01	0.98
ACH580-31	1.0
Efficiency at rated power	
ACH580-01	98.0%
ACH580-31	96.5%
Power Loss	Approximately 2% of rated power

Motor connection

Supported motor control	Scalar and vector
Supported motor types	Asynchronous motor, permanent magnet motor (vector), SynRM (vector)
Voltage	3-phase, from 0 to supply voltage
Frequency	0 to 500 Hz
Short Term Overload Capacity Variable Torque	110% for 1 min/10min
Peak Overload Capacity Variable Torque	1.35 for 2 second (2 sec / 10 min)
Switching Frequency	2, 4, 8 or 12 kHz Automatic fold back in case of overload
Acceleration/Deceleration Time	0 to 1800 s
Short Circuit Current Rating (SCCR)	100 ka with fusing

Inputs and outputs (drive)

2 analog inputs	Selection of Current/Voltage input mode is user programmable.
Voltage reference	0 (2) to 10 V, $R_{in} > 200 \text{ k}\Omega$
Current reference	0 (4) to 20 mA, $R_{in} = 100 \Omega$
Potentiometer reference value	10 V $\pm 1\%$ max. 20 mA
2 analog outputs	AO1 is user programmable for current or voltage. AO2 current
Voltage reference	0 to 10 V, $R_{load} > 100 \text{ k}\Omega$
Current reference	0 to 20 mA, $R_{load} < 500 \Omega$
Applicable potentiometer	1 k Ω to 10 k Ω
Internal auxiliary voltage	24 V DC $\pm 10\%$, max. 250 mA
Accuracy	+/- 1% full scale range at 25°C (77°F)
Output updating time	2 ms
6 digital inputs	12 to 24 V DC, 10 to 24 V AC, Connectivity of PTC sensors supported by a single digital input.

	PNP or NPN connection (5 DI's with NPN connection). Programmable
Input Updating Time	2 ms
3 relay outputs	Maximum switching voltage 250 V AC/30 V DC. Maximum continuous current 2 A rms. Programmable, Form C
Adjustable filters on analog inputs and outputs	
All control inputs isolated from ground and power	
Operation	
Air temperature	0 to -15 °C (32 to 5 °F). -15 to +50 °C (5 to 122 °F): No frost allowed. Output derated above +40 °C (104 °F)
Installation site altitude	0 to 4000 m (13123 ft) above sea level Output derated above 1000 m (3281 ft)
Relative humidity	5 to 95% No condensation allowed Maximum relative humidity is 60% in the presence of corrosive gasses
Atmospheric pressure	70 to 106 kPa (10.2 to 15.4 PSI) 0.7 to 1.05 atmospheres
Vibration	Risk category IV Certified (IBC 2018)
Environmental protections	
Chemical Gasses	Class 3C2
Solid Particles	Class 3S2 No conductive dust allowed
Pollution degree (IEC/EN 61800-5-1)	Pollution degree 2
Product compliance	
Standards and directives	Low Voltage Directive 2006/95/EC EMC Directive 2004/108/EC 60721-3-3: 2002 60721-3-1:1997 Quality assurance system ISO 9001 and Environmental system ISO 14001 CE, UL, cUL, and EAC approvals Galvanic isolation according to PELV RoHS2 (Restriction of Hazardous Substances) EN 61800-5-1: 2007; IEC/EN 61000-3-12; EN61800-3: 2017 + A1: 2012 Category C2 (1st environment restricted distribution); Safe torque off (EN 61800-5-2) BACnet Testing Laboratory (BTL) Seismic (IBC, OSHPD) Plenum (ACH580-01 only)
EMC (according to EN61800-3)	ACH580-01 and ACH580-31 class C2 (1st environment restricted distribution)

Storage (in Protective Shipping Package)

Air Temperature	-40 to +70 °C (-40 to +158 °F)
Relative Humidity	Less than 95% No condensation allowed Maximum relative humidity is 60% in the presence of corrosive gasses
Chemical Gasses	Class 1C2
Solid Particles	Class 1S2 Contact ABB regarding Class 1S3
Atmospheric pressure	70 to 106 kPa 0.7 to 1.05 atmospheres
Vibration (ISTA)	
R1...R4	In accordance with ISTA 1A
R5...R9	In accordance with ISTA 3E

Transportation (in Protective Shipping Package)

Air Temperature	-40° to 70°C (-40° to 158°F)
Relative Humidity	Less than 95% No condensation allowed Maximum relative humidity is 60% in the presence of corrosive gasses
Atmospheric Pressure	60 to 106 kPa (8.7 to 15.4 PSI) 0.6 to 1.05 atmospheres
Free Fall	R1: 76 cm (30 in) R2: 61 cm (24 in) R3: 46 cm (18 in) R4: 31 cm (12 in) R5: 25 cm (10 in)
Chemical Gasses	Class 2C2
Solid Particles	Class 2S2
Shock/ Drop (ISTA)	
R1...R4	In accordance with ISTA 1A
R5...R9	In accordance with ISTA 3E
Vibration (ISTA)	
R1...R4	In accordance with ISTA 1A
R5...R9	In accordance with ISTA 3E

Feature overview

Communication

Protocols as standard (EIA-485): BACnet MS/TP, Modbus RTU, Johnson Controls N2

Available as plug-in options: BACnet/IP, Modbus TCP, PROFIBUS-DP, DeviceNet, EtherNet/IP, LonWorks (coming 2019)

Application functions

Start interlock

Delayed start

Run permissive (damper monitoring)

Override operation mode

Real-time clock (scheduling)

PID controllers for motor and process

Motor flying start

Motor preheating

Energy optimizer and calculators

Timer

2 or 3 wire start/stop

Ramp to stop

2 independent adjustable accel/decel ramp

Protection functions

Overvoltage controller

Undervoltage controller

Motor earth-leakage monitoring

Motor short-circuit protection

Motor overtemperature protection

Output and input switch supervision

Motor overload protection (UL508C)

Phase-loss detection (both motor and supply)

Under load supervision (belt loss detection)

Overload supervision

Stall protection

Loss of reference

Panel loss

Ground fault

External events

Overcurrent

Current limit regulator

Transient/Surge protection (MOV and choke)

Panel functions

First start assistant

Primary settings for HVAC applications

Hand-Off-Auto operation mode

HVAC quick set-up

Includes Day, Date and Time

Operator Panel Parameter Backup (read/write)

Full Graphic and Multilingual Display for Operator Control,

Parameter Set-Up and Operating Data Display:

- Output Frequency (Hz)
- Speed (RPM)
- Motor Current
- Calculated % Motor Torque
- Calculated Motor Power (kW)
- DC Bus Voltage
- Output Voltage
- Heatsink Temperature
- Elapsed Time Meter (resettable)

- kWh (resettable)
- Input / Output Terminal Monitor
- PID Actual Value (Feedback) & Error Fault Text
- Warning Text
- Three (3) Scalable Process Variable Displays
- User-Definable Engineering Units

Motor control features

Scalar (V/Hz) and vector modes of motor control

V/Hz shapes

- Linear
- Squared

Energy optimization

IR compensation

Slip compensation

Three (3) Critical Frequency Lockout Bands

PID control

One (1) Process PID

Four (4) Integral Independent Programmable PID

Setpoint Controllers (Process and External)

External Selection between Two (2) Sets of Process

PID Controller Parameters

PID Sleep/Wake-Up

Control panel features

The ACH580 Assistant Control Panel features:

- Intuitive to operate
- Primary Setting menu to ease drive commissioning
- Real-time clock
- Diagnostic and maintenance functions
- Full-graphic display, including chart, graph, and meter options
- 21 editable home views
- USB interface for PC and tool connection as standard
- Parameters are alpha-numeric
- North American version supports 14 languages as standard
- Dedicated "Help" key
- 4 user sets
- Parameters are stored in control panel memory for later transfer to other drives or for backup of a particular system
- Back-up and restore parameters and/or motor data
- Automatic back-up 2 hours after parameter change
- Modified parameter display
- Creates unique short menu
- Shows parameters that differ from the default
- Bluetooth connectivity for use with mobile device (requires +J429 option)

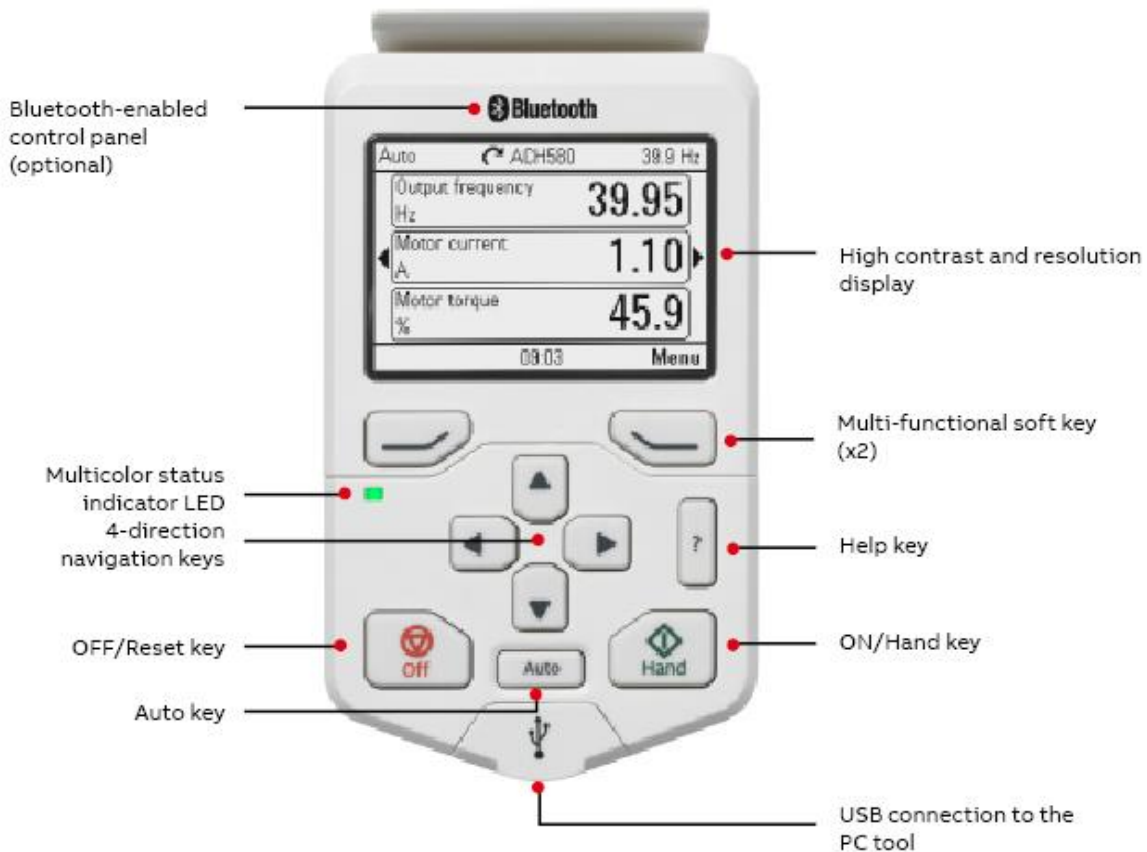

Cable connections

The following illustrations show the ACH580-01 and ACH580-31 cable connection points for the base drive. The illustrations indicate the location of input and output power connections as well as equipment and motor grounding connection points.

ACH580 drives are configured for wiring access from the bottom only. At least three separate metallic conduits are required, one for input power, one for output power to the motor and one for control signals.

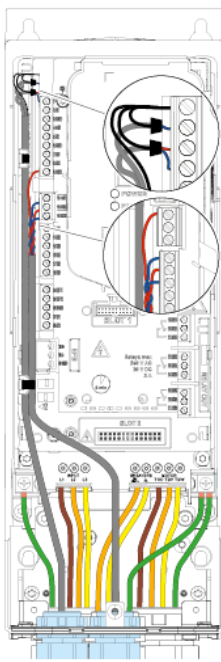

ACH580-01, R1-R2, UL (NEMA) Type 1 and 12

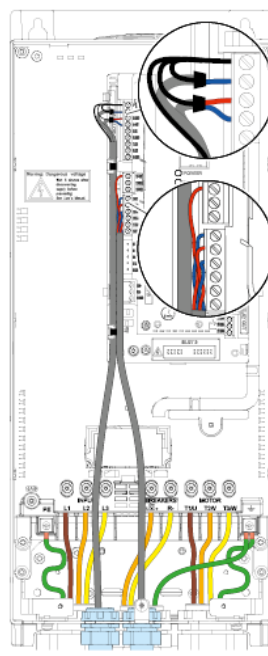

ACH580-01, R3, UL (NEMA) Type 1 and 12

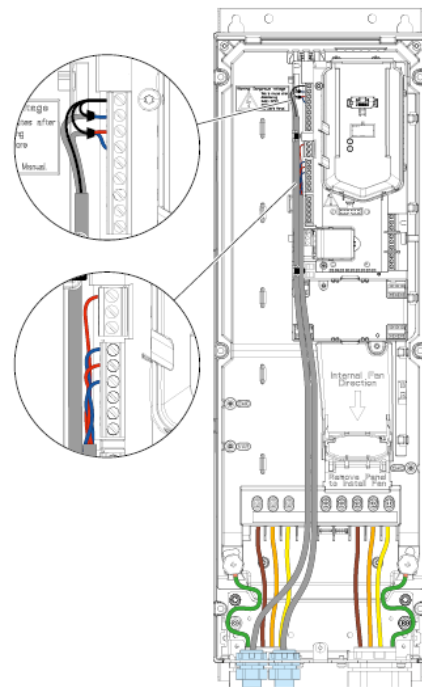

ACH580-01, R4, UL (NEMA) Type 1 and 12

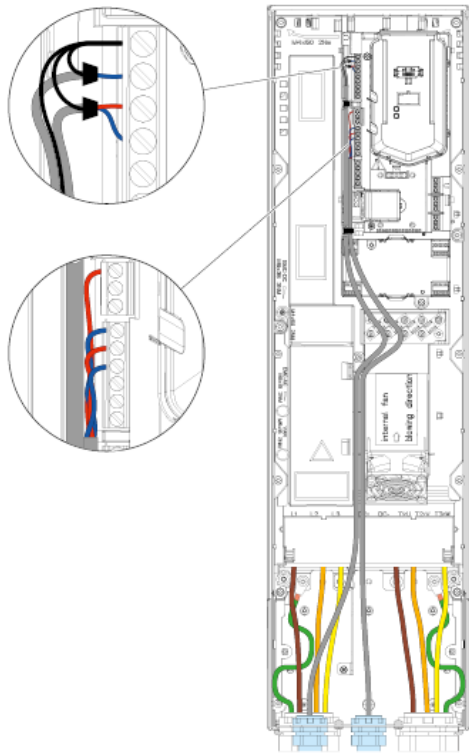

ACH580-01, R5, UL (NEMA) Type 1 and 12

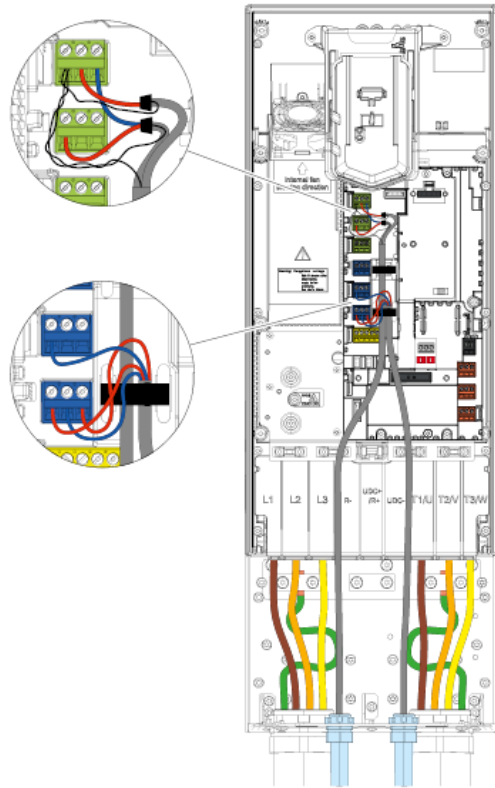

ACH580-01, R6-9, UL (NEMA) Type 1 and 12

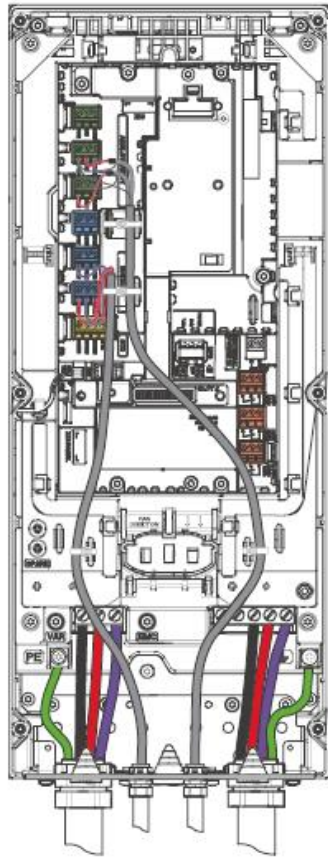

ACH580-31, R3, UL (NEMA) Type 1 and 12

Control connections

Default control connections

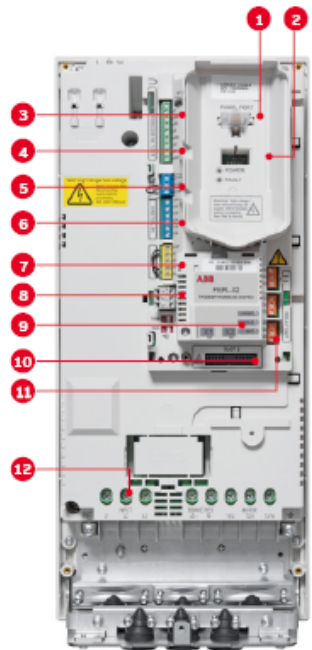

1. Panel port (PC tools, control panel)
2. ABB drive customizer port for programming the drive without mains
3. Analog inputs (2 × AI)
4. Analog outputs (2 × AO)
5. 24 V DC output
6. Digital inputs (6 × DI)
7. Safe torque off (STO)
8. Embedded fieldbus
9. Communication options (fieldbuses)
10. Analog and digital I/O extensions
11. Relay outputs (3 × RO)
12. Mains connection

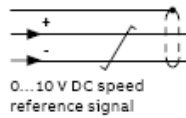

Terminal	Meaning	Default macro connections	
X1 Reference voltage and analog inputs and outputs			
1	SCR	Signal cable shield (screen)	
2	AI1	Output frequency/speed reference: 0 to 10 V	
3	AGND	Analog input circuit common	
4	+10 V	Reference voltage 10 V DC	
5	AI2	Actual feedback: 0 to 20 mA	
6	AGND	Analog input circuit common	
7	AO1	Output frequency: 0 to 10 V	
8	AO2	Motor current: 0 to 20 mA	
9	AGND	Analog output circuit common	
X2 & X3 Aux. voltage output and programmable digital inputs			
10	+24 V	Aux. voltage output +24 V DC, max. 250 mA	
11	DGND	Aux. voltage output common	
12	DCOM	Digital input common for all	
13	DI1	Stop (0)/Start (1)	
14	DI2	Not configured	
15	DI3	Constant frequency/speed selection	
16	DI4	Start interlock 1 (1 = allow start)	
17	DI5	Not configured	
18	DI6	Not configured	
X6, X7, X8 Relay outputs			
19	RO1C	Damper control 250 V AC/30 V DC 2 A	Energize damper 19 connected to 21
20	RO1A		
21	RO1B	Running 250 V AC/30 V DC 2 A	Running 22 connected to 24
22	RO2C		
23	RO2A	Fault (-1) 250 V AC/30 V DC 2 A	Fault condition 25 connected to 26
24	RO2B		
25	RO3C		
26	RO3A		
27	RO3B		
X5 Embedded fieldbus			
29	B+		
30	A-	Embedded fieldbus, EFB (EIA-485)	
31	DGND		
54	TERM	Termination switch	
55	BIAS	Bias resistors switch	
X4 Safe torque off			
34	OUT1	Safe torque off. Factory connection. Both circuits must be closed for the drive to start. See chapter <i>The Safe torque off function</i> in the <i>hardware manual</i> of the drive.	
35	OUT2		
36	SGND		
37	IN1		
38	IN2		
X10 24 V AC/DC			
40	24 V AC/DC+ in	R6-R11 only: Ext. 24 V AC/DC input to power up the control unit when the main supply is disconnected.	
41	24 V AC/DC- in		

Notes:

- Connected with jumpers at the factory.
- Only frames R6-R11 have terminals 40 and 41 for external 24 V AC/DC input.

PRODUCT OVERVIEW

ACH580 E-Clipse Bypass

The ACH580 drive sets new standards in both simplicity and reliability, and ensures smooth, energy-efficient operation of your HVAC systems in normal and mission-critical situations.

The ACH580 with ABB E-Clipse bypass is an ACH580 HVAC Drive in an integrated UL (NEMA) Type 1, 12 or 3R enclosure with a bypass motor starter. The ACH580 with ABB E-Clipse bypass provides an input disconnect switch or circuit breaker with door mounted and interlocked operator (padlockable in the OFF position), a bypass starter, electronic motor overload protection, a door mounted control panel with graphical display for local control, provisions for external control connections, and serial communications capability. Configurations with the +F267 option include a drive service switch.

UL (NEMA) Type 1 and 12 E-Clipse units are available from 1 to 100 HP at 208/230V, 1 to 350 HP at 460V, and 2 to 150 HP at 575V. UL (NEMA) Type 1 and 12 units are wall mounted from 1 to 200 HP.

For outdoor applications, UL (NEMA) Type 3R E-Clipse unit are available from 1 to 100 HP at 208/230V, 1 to 350 HP at 460V and 2 to 150 HP at 575V. Construction is sheet steel with a tough powder coat paint finish for corrosion resistance. A thermostatically controlled space heater and forced ventilated air cooling system are standard.

The ACH580 with ABB E-Clipse bypass includes two contactors. One contactor is the bypass contactor, used to connect the motor directly to the incoming power line in the event that the ACH580 is out of service. The other contactor is the ACH580 output contactor that disconnects the ACH580 from the motor when the motor is operating in the Bypass mode. The drive output contactor and the bypass contactor are electrically interlocked to prevent “back feeding”.

The ACH580 with ABB E-Clipse bypass is a microprocessor-controlled “intelligent” system which features programmable Class 10, 20, or 30 overload curves, programmable underload (broken belt) and overload trip or indication. Also included as standard features are single-phase protection in bypass mode, programmable manual or automatic transfer to bypass, fireman’s override, smoke control, damper control, no contactor chatter on brown-out power conditions and serial communications. Should a drive problem occur, fast acting fuses exclusive to the ACH580 drive path disconnect the drive from the line prior to clearing upstream branch circuit protection, maintaining bypass capability.

Technical specifications

Product compliance (complete list on following page)

ACH580-VxR/BxR	UL508A
----------------	--------

Supply connection

Input voltage (U ₁)	
ACH580-xx-xxxA-2	208/240V
ACH580-xx-xxxA-4	480V
ACH580-xx-xxxA-6	600V
Input voltage tolerance	+10% / -15%
Phase	3-phase
Frequency	48 to 63 Hz
Line Limitations	Max ±3% of nominal phase to phase input voltage
Power Factor (cos φ) at nominal load	
ACH580-VxR	0.98
ACH580-BxR	0.98
Efficiency at rated power	
ACH580-VxR	98.0%
ACH580-BxR	98.0%
Power Loss	Approximately 2% of rated power

Motor connection

Supported motor control	Scalar and vector
Supported motor types	Asynchronous motor
Voltage	3-phase, from 0 to supply voltage
Frequency	0 to 500 Hz
Short Term Overload Capacity Variable Torque	110% for 1 min/10min
Peak Overload Capacity Variable Torque	1.35 for 2 second (2 sec / 10 min)
Switching Frequency	2, 4, 8 or 12 kHz Automatic fold back in case of overload
Acceleration/Deceleration Time	0 to 1800 s
Short Circuit Current Rating (SCCR)	

	240V	480V	600V
-VCR	100kA	100kA	10 kA
-VDR*	100kA	100kA	100 kA
-BCR	100kA	100kA	10 kA
-BDR*	100kA	100kA	100 kA

* External fuses are required for 100 kA rating as specified in the "Technical Data" section of User Manual [3AXD50000289554](#).

Technical specifications

Inputs and outputs (drive)	
2 analog inputs	Selection of Current/Voltage input mode is user programmable.
Voltage reference	0 (2) to 10 V, $R_{in} > 200 \text{ k}\Omega$
Current reference	0 (4) to 20 mA, $R_{in} = 100 \Omega$
Potentiometer reference value	10 V $\pm 1\%$ max. 20 mA
2 analog outputs	AO1 is user programmable for current or voltage. AO2 current
Voltage reference	0 to 10 V, $R_{load} > 100 \text{ k}\Omega$
Current reference	0 to 20 mA, $R_{load} < 500 \Omega$
Applicable potentiometer	1 k Ω to 10 k Ω
Internal auxiliary voltage	24 V DC $\pm 10\%$, max. 250 mA
Accuracy	+/- 1% full scale range at 25°C (77°F)
Output updating time	2 ms
6 digital inputs	12 to 24 V DC, 10 to 24 V AC, Connectivity of PTC sensors supported by a single digital input. PNP or NPN connection (5 DIs with NPN connection). Programmable
Input Updating Time	2 ms
3 relay outputs	Maximum switching voltage 250 V AC/30 V DC. Maximum continuous current 2 A rms. Programmable, Form C
Contact material	Silver Tin Oxide (AgSnO ₂)
PTC, PT100 and PT1000	Any of the analog inputs, or digital input 6, are configurable for PTC with up to 6 sensors.
Adjustable filters on analog inputs and outputs	
All control inputs isolated from ground and power	
Operation	
Air temperature	0 to -15 °C (32 to 5 °F). -15 to +50 °C (5 to 122 °F): No frost allowed. Output derated above +40 °C (104 °F)
Installation site altitude	0 to 1000 m (3281 ft) above sea level Output derated above 1000 m (3281 ft)
Relative humidity	5 to 95% No condensation allowed Maximum relative humidity is 60% in the presence of corrosive gasses
Atmospheric pressure	70 to 106 kPa (10.2 to 15.4 PSI) 0.7 to 1.05 atmospheres
Seismic	Risk category IV Certified (IBC 2018)

Feature overview

Communication

Protocols as standard (EIA-485): BACnet MS/TP, Modbus RTU, Johnson Controls N2
Available as plug-in options: BACnet/IP, Modbus TCP, PROFIBUS-DP, DeviceNet, EtherNet/IP

Application functions

Start interlock
Delayed start
Run permissive (damper monitoring)
Override operation mode
Real-time clock (scheduling)
PID controllers for motor and process
Motor flying start
Motor preheating
Energy optimizer and calculators
Timer
2 or 3 wire start/stop
Ramp to stop
2 independent adjustable accel/decel ramp

Protection functions

Overvoltage controller
Undervoltage controller
Motor earth-leakage monitoring
Motor short-circuit protection
Motor overtemperature protection
Output and input switch supervision
Motor overload protection (UL508C)
Phase-loss detection (both motor and supply)
Under load supervision (belt loss detection)
Overload supervision
Stall protection
Loss of reference
Panel loss
Ground fault
External events
Overcurrent
Current limit regulator
Transient/Surge protection (MOV and choke)

Panel functions

First start assistant
Primary settings for HVAC applications
Hand-Off-Auto operation mode
HVAC quick set-up
Includes Day, Date and Time
Operator Panel Parameter Backup (read/write)
Full Graphic and Multilingual Display for Operator Control,
Parameter Set-Up and Operating Data Display:

- Output Frequency (Hz)
- Speed (RPM)
- Motor Current
- Calculated % Motor Torque
- Calculated Motor Power (kW)

- DC Bus Voltage
- Output Voltage
- Heatsink Temperature
- Elapsed Time Meter (resettable)
- kWh (resettable)
- Input / Output Terminal Monitor
- PID Actual Value (Feedback) & Error Fault Text
- Warning Text
- Three (3) Scalable Process Variable Displays
- User-Definable Engineering Units

Motor control features

Scalar (V/Hz) and vector modes of motor control
V/Hz shapes

- Linear
- Squared

Energy optimization
IR compensation
Slip compensation
Three (3) Critical Frequency Lockout Bands

PID control

One (1) Process PID
Four (4) Integral Independent Programmable PID Setpoint Controllers (Process and External)
External Selection between Two (2) Sets of Process PID Controller Parameters
PID Sleep/Wake-Up

Control panel features

The ACH580 Assistant Control Panel features:

- Intuitive to operate
- Primary Setting menu to ease drive commissioning
- Real-time clock
- Diagnostic and maintenance functions
- Full-graphic display, including chart, graph, and meter options
- 21 editable home views
- USB interface for PC and tool connection as standard
- Parameters are alpha-numeric
- North American version supports 14 languages as standard
- Dedicated "Help" key
- 4 user sets
- Parameters are stored in control panel memory for later transfer to other drives or for backup of a particular system
- Back-up and restore parameters and/or motor data
- Automatic back-up 2 hours after parameter change
- Modified parameter display
- Creates unique short menu
- Shows parameters that differ from the default
- Bluetooth connectivity for use with mobile device (requires +J429 option)

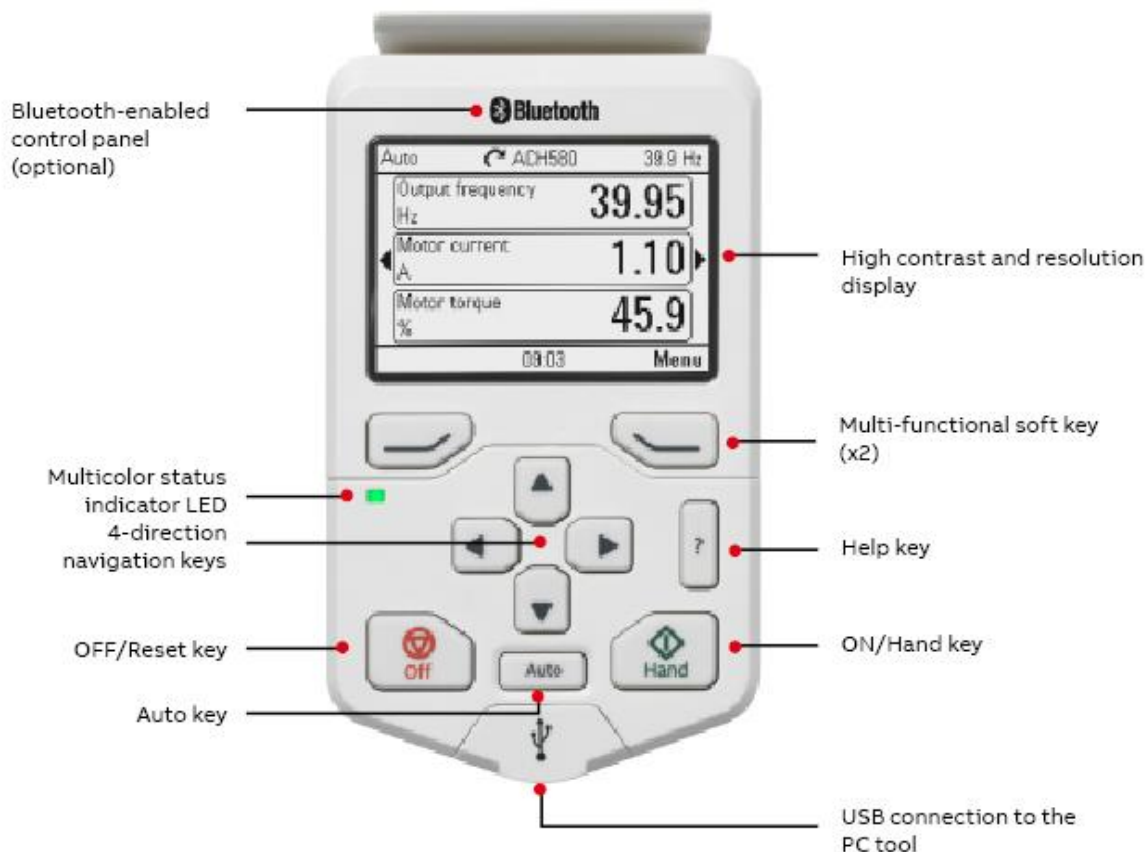

E-Clipse control panel features

The ACH580 E-Clipse Control Panel features:

- Dedicated programming and operating controls (keys) are logically grouped on the keypad by their function.
 - o H-O-A, Drive/Bypass Selection keys (Control)
 - o UP/DOWN arrows, ESC, ENTER keys (Programming)
- LCD display provide:
 - o Operating Control Status
 - o Bypass Status
 - o Fault/Warning annunciation
 - o Parameter Lists and Values
 - o Power On indication
- Individual LEDs arranged to provide a logical control path visual:
 - o System Enabled
 - o Separate multi colored Drive and Bypass "SELECTED/FAULTED LEDs in separate paths
 - o Motor Run Indicator
 - o LEDs that illuminate, change color, and flash to provide visible indication of system status
- Provides System control from one location

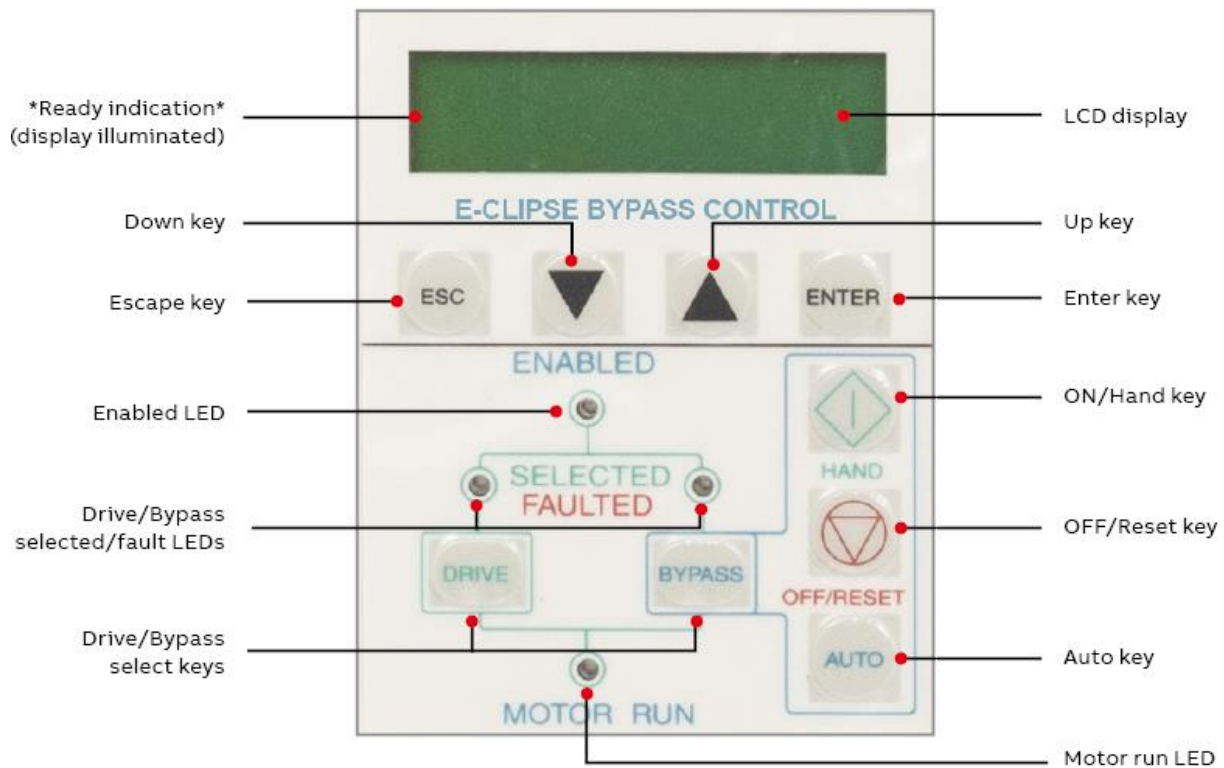

Cable connections

The following illustrations show the ACH580 with ABB E-Clipse bypass cable connection points for the various enclosure styles. The illustrations indicate the location of input and output power connections as well as equipment and motor grounding connection points.

ACH580 drives are configured for wiring access from the bottom only on Vertical ABB E-Clipse bypass units and from the top only on Standard ABB E-Clipse bypass units. At least three separate metallic conduits are required, one for input power, one for output power to the motor and one for control signals.

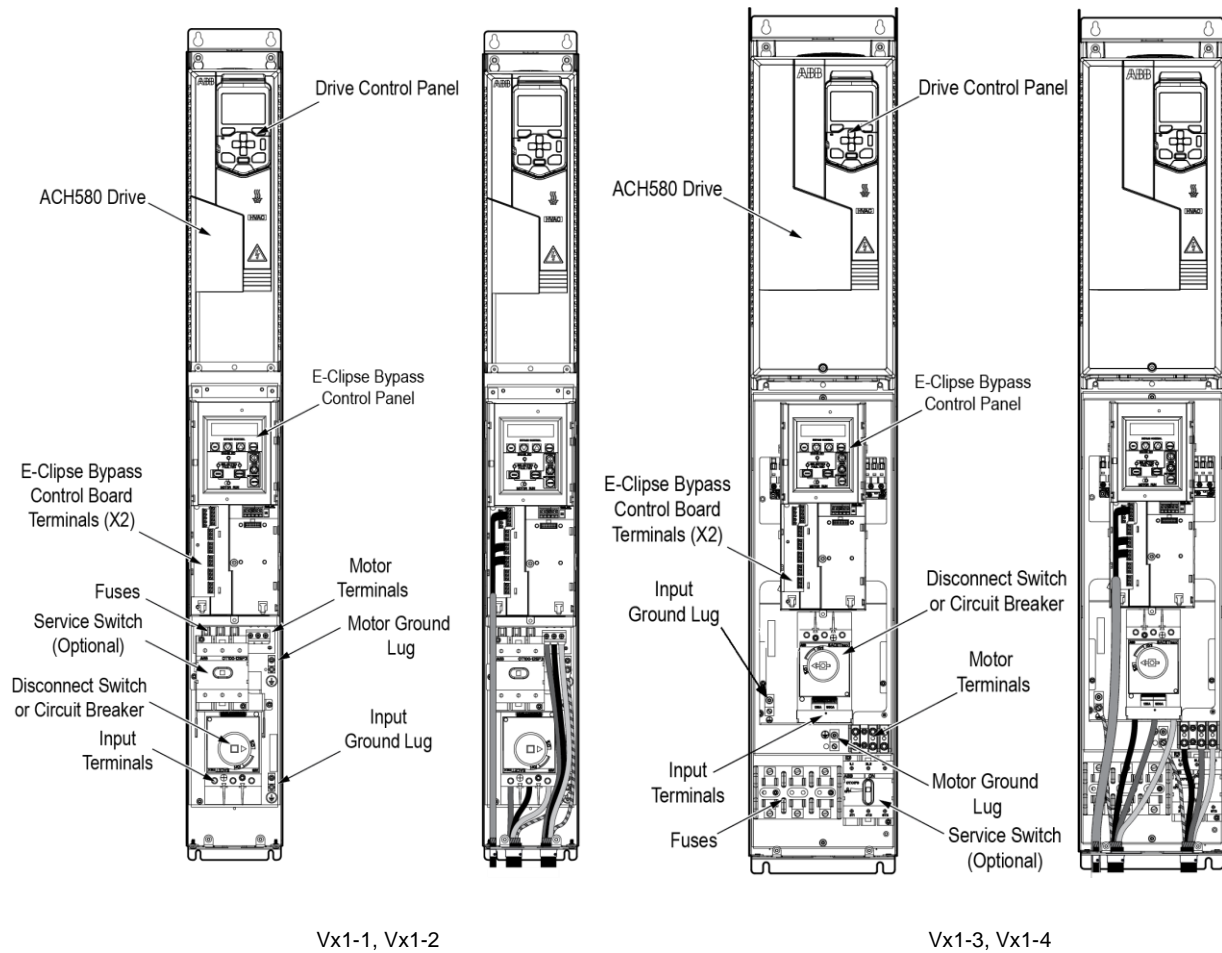

Cable connections

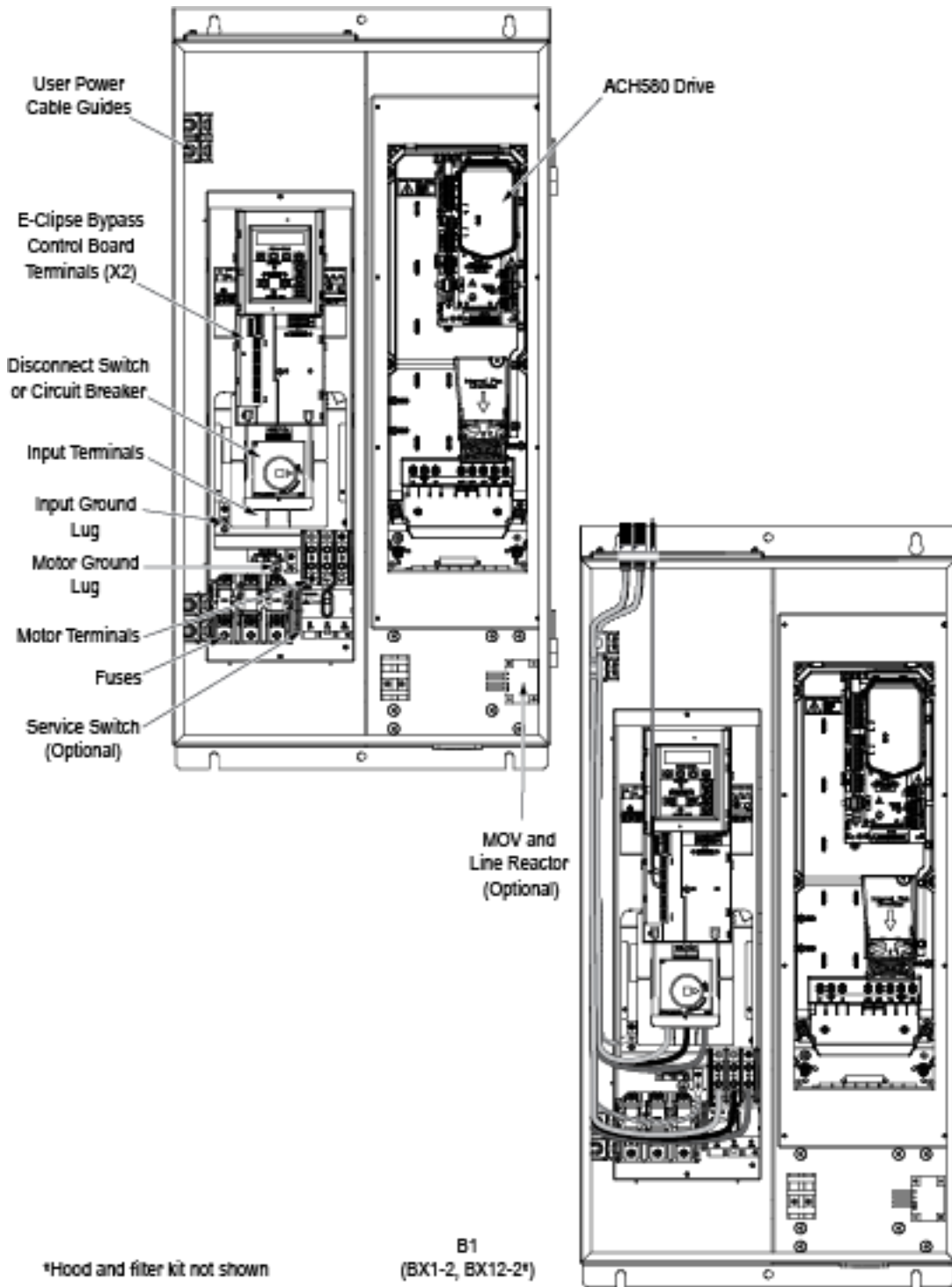

Bx1-1, Bx12-1, Bx3R-1

Control connections

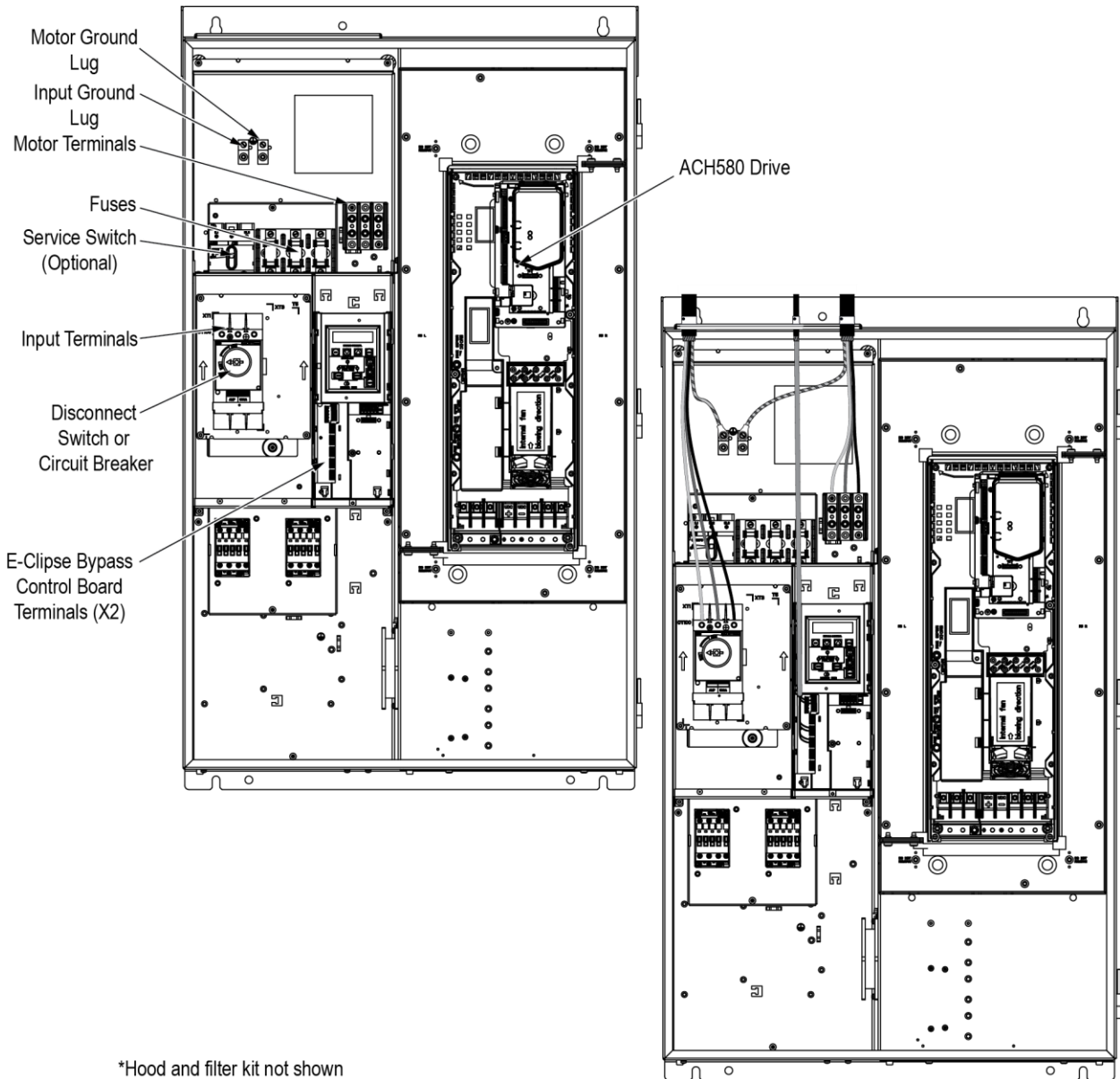

Bx1-3*, Bx12-3*

Control connections

The control wiring includes connections to an analog speed command signal and a start/stop relay contact for controlling the motor in the AUTO mode. There may also be connections to external run permissive interlock contacts and a connection from the Motor Run contact to an external status indication circuit. For a detailed description of the control circuit functions and alternate Control Connection diagrams, refer to the ACH580 E-Clipse bypass and packaged drive manual.

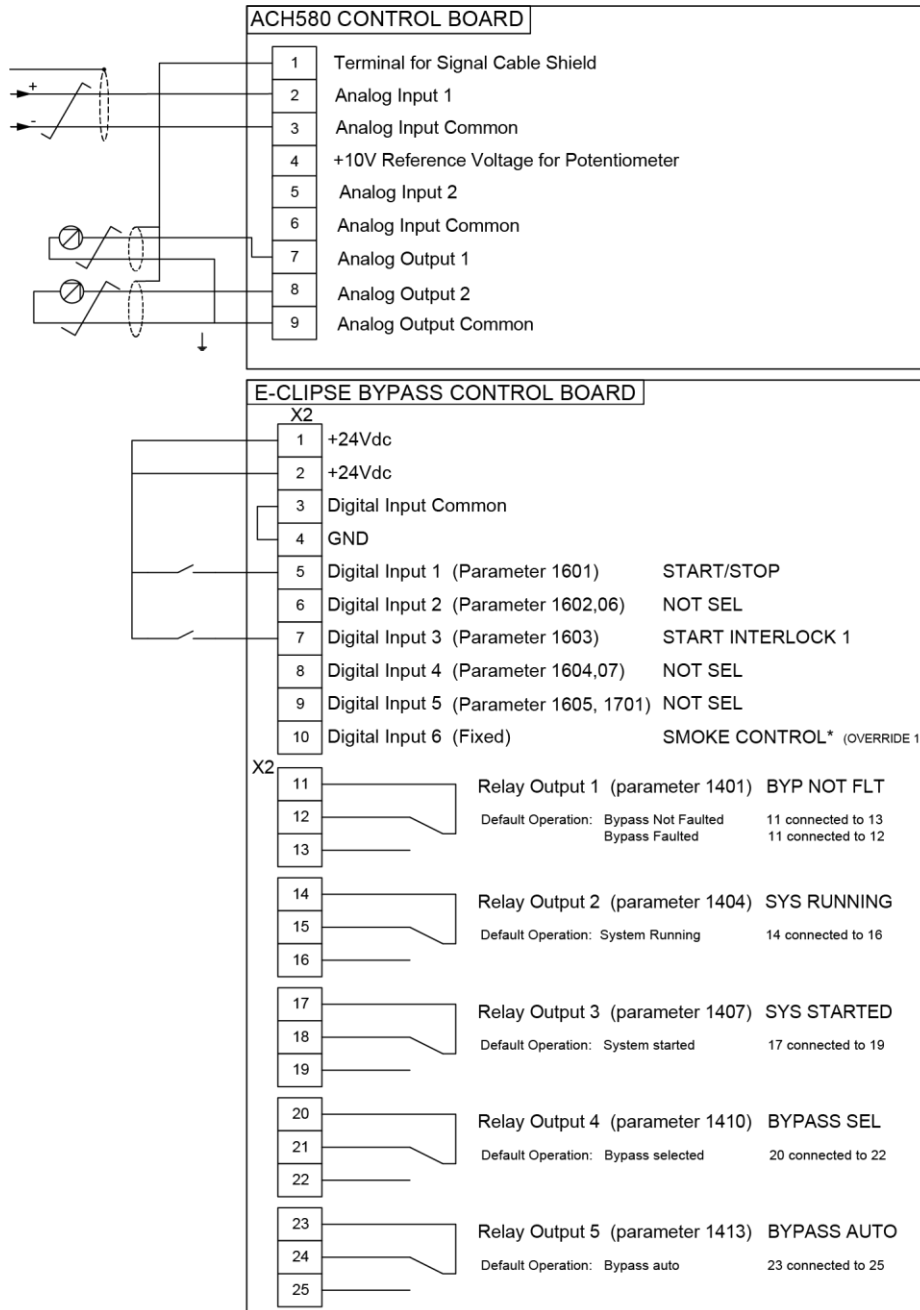

Engineering Data Summary

Replacement Fuses

Drive input fuses are recommended to disconnect the drive from power in the event that a component fails in the drive's power circuitry. Recommended drive input fuse specifications are listed in the *Submittal Schedule Details* and in the *Fuse Ratings Table*. Fuse rating information is provided for customer reference.

Item	Catalog Number	Drive Input Fuse Ratings	
		Amps (600V)	Bussmann Type
1	ACH580-VDR-052A-4	80	Class T

Terminal Sizes / Cable Connection Requirements

Power and motor cable terminal sizes and connection requirements are shown in the *Submittal Schedule Details* and in the *Terminal Sizes / Cable Connection Requirements Table*. The information provided below is for connections to input power and motor cables. These connections may be made to an input circuit breaker or disconnect switch, a motor terminal block, overload relay, and/or directly to bus bars and ground lugs. The table also lists torque that should be applied when tightening terminals and spacing requirements where multiple mounting holes are provided in the bus bar.

Item	Catalog Number	Input Wiring	Output Wiring	Ground Wiring
1	ACH580-VDR-052A-4	#14...#4 4.6 lbf-ft	#14...#2 #14...#8: 35 in-lbs; #6...#4: 45 in-lbs; #3...#2: 50 in-lbs	#14...#2 #14...#10: 2.9 lbf-ft; #6...#4: 3.8 lbf-ft; #2: 4.1 lbf-ft

Heat Dissipation Requirements

The cooling air entering the drive must be clean and free from corrosive materials. The *Submittal Schedule Details* and the *Heat Dissipation Requirements table* below give the heat dissipated into the hot air exhausted from the drives. If the drives are installed in a confined space, the heat must be removed from the area by ventilation or air conditioning equipment.

Item	Catalog Number	Watts	BTU/Hr
1	ACH580-VDR-052A-4	918	3,130

Dimensions and Weights

Dimensions and weights of the drives provided are given in the *Submittal Schedule Details* and in the *Dimensions and Weights Table*. The table also lists the applicable dimension drawings that include additional detail. Dimension drawings may be provided in the back of this submittal.

Item	Catalog Number	Height mm (in)	Width mm (in)	Depth mm (in)	Weight kg (lbs)
1	ACH580-VDR-052A-4	1443 (56.82)	214 (8.43)	305 (12.01)	39 (86)

Product Short Circuit Current Rating

Short circuit ratings shown below are as show on the device rating label.

Item	Catalog Number	Short Circuit Current Rating
1	ACH580-VDR-052A-4	100 kA with fusing

Item 1	Part Number ACH580-VDR-052A-4	Customer Designation
------------------	---	-----------------------------

F-3BLAC09802-4, rev. 0 8-21-03

We reserve all rights in this document and the information contained therein. Reproduction, use, or disclosure to third parties without express written authority is strictly forbidden. © ABB Automation Inc. (US)

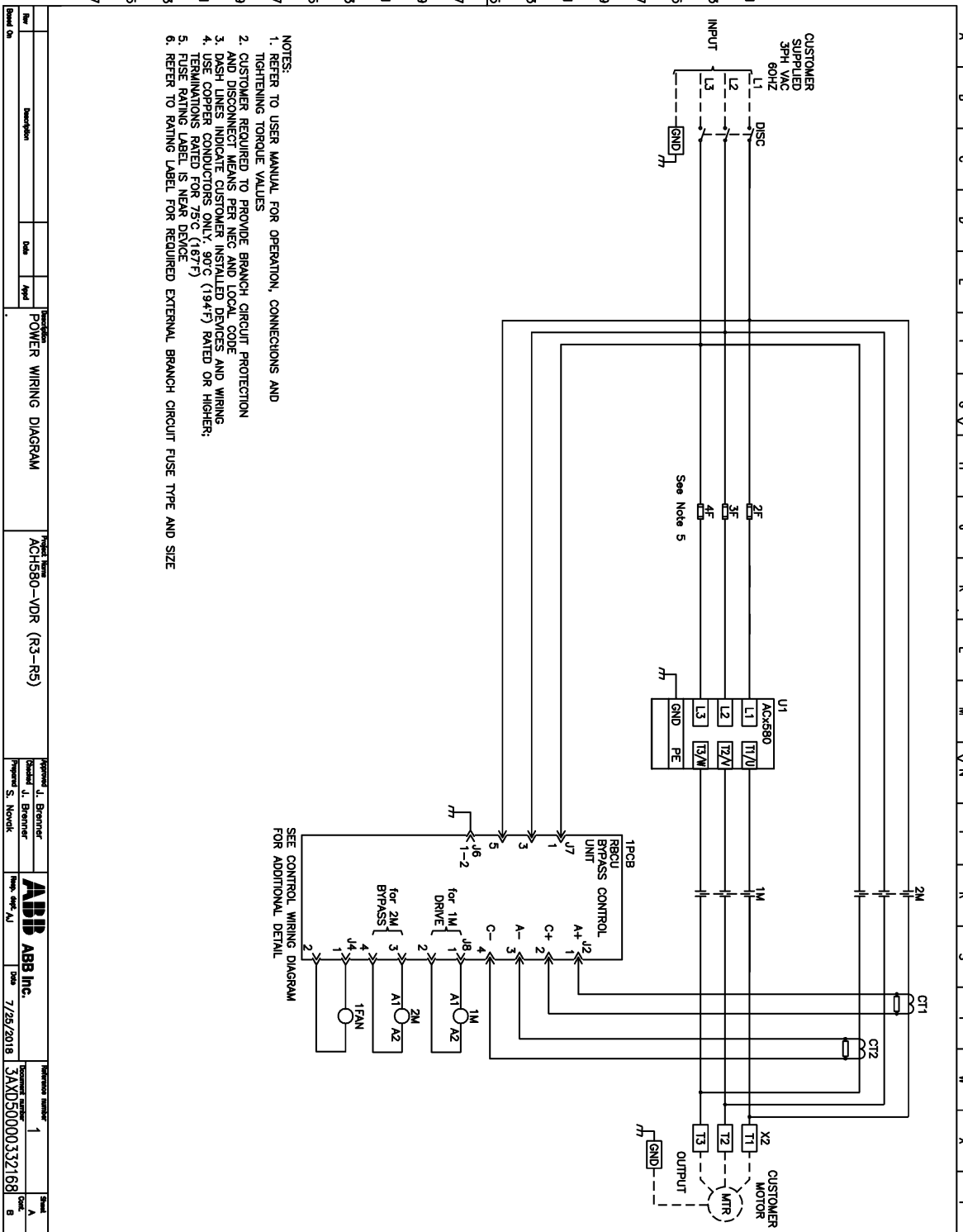

{3AXD50000332168_1.png}

Item	Part Number	Customer Designation
1	ACH580-VDR-052A-4	

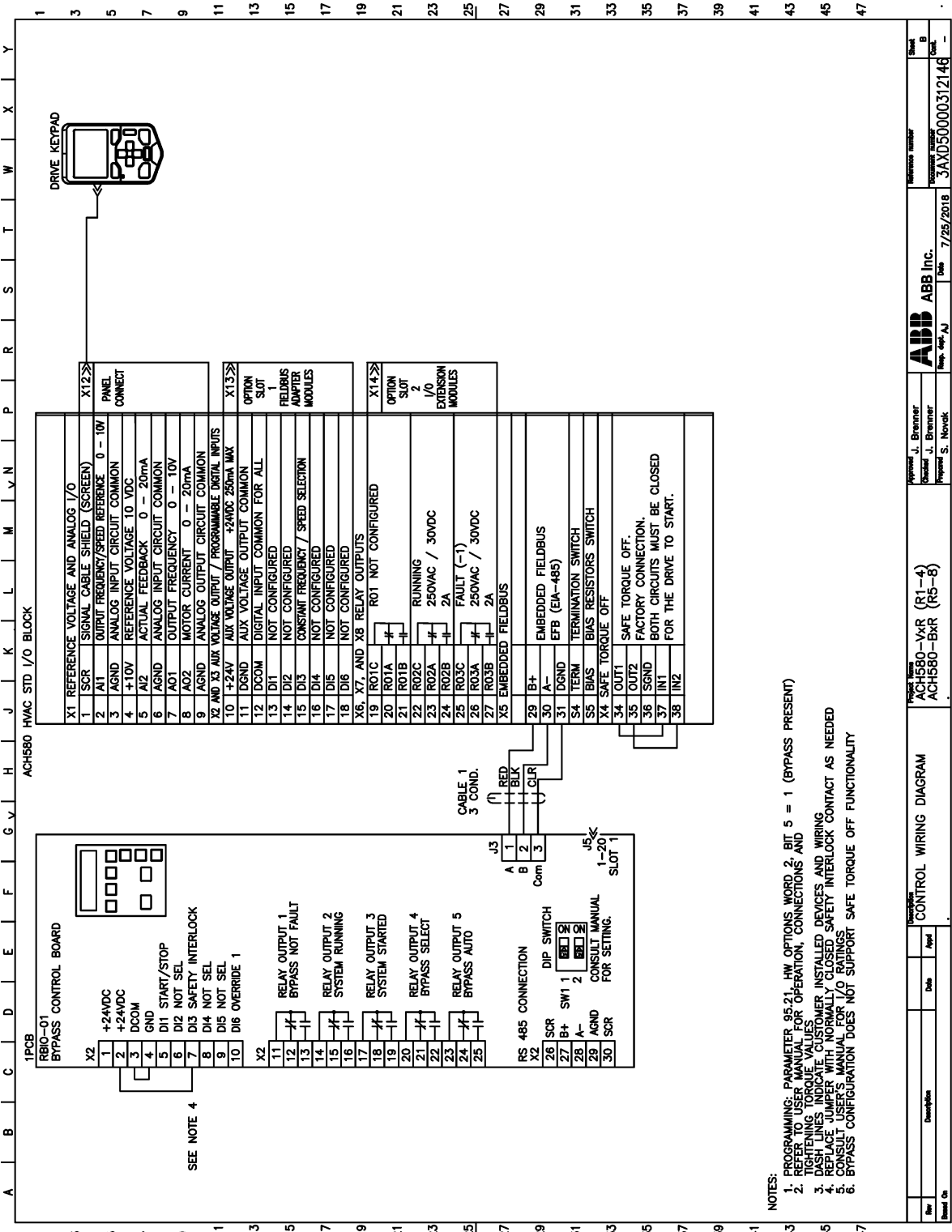

- NOTES:**
- PROGRAMMING: PARAMETER 95.21, HW OPTIONS WORD 2, BIT 5 = 1 (BYPASS PRESENT)
 - REFER TO USER MANUAL FOR OPERATION, CONNECTIONS AND WIRING
 - USING THIS INVERSE ALUSE, THE USER MUST REMOVE THE SAFETY INTERLOCK CONTACT AS NEEDED
 - REPLACE JUMPER WITH NORMALLY CLOSED SAFETY INTERLOCK CONTACT AS NEEDED
 - CONSULT USER'S MANUAL FOR I/O RATINGS
 - BYPASS CONFIGURATION DOES NOT SUPPORT SAFE TORQUE OFF FUNCTIONALITY

Rev	Description	Date	App'd	Checked	Control Wiring Diagram	Project Name	ACH580-VxR (R1-4) ACH580-BxR (R5-8)	Project Manager	ABB ABB Inc.	Date	7/25/2018	Reference number	3AXD50000312146	Sheet	2 of 2
								Approved	J. Brenner						
								Checked	J. Brenner						
								Prepared	S. Novak						

{3AXD50000312146.png}

Item 1	Part Number ACH580-VDR-052A-4	Customer Designation
-----------	----------------------------------	----------------------

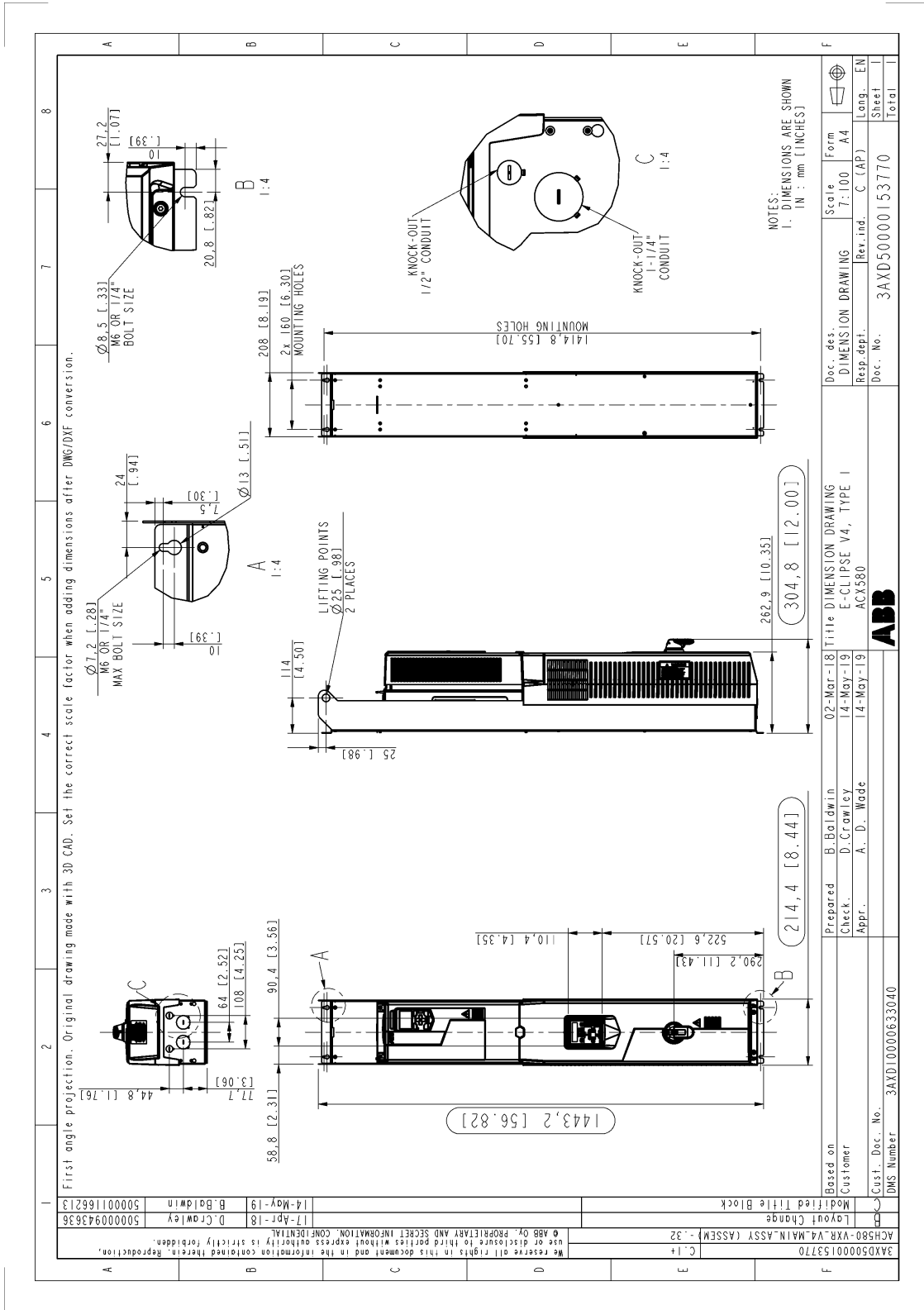

{3AXD50000153770.png}